

# VELANSO

## Specification Sheet

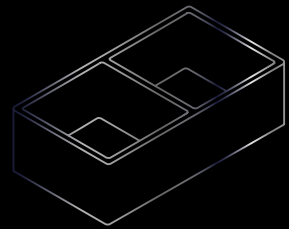

Model: F8030

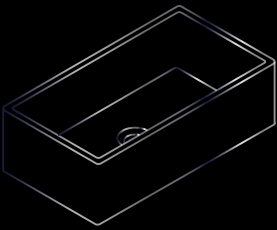
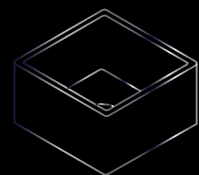
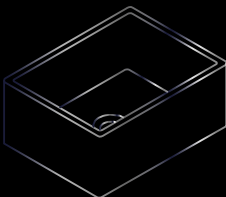
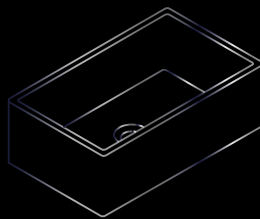

**Model Code:** F8030

### ■ Features

- Single Bowl
- 3.5" Drain Opening
- Fit Minimum 33" Base Cabinet
- Center Drain
- Material: Fireclay
- Undermount or flush mount installation



### ■ Available Colors

NAME	CODE
• Bright White	BW
• Matte White	MW
• Bright Black	BB
• Matte Black	MB
• Anthracite	A
• Mustard	M
• Silver Gray	SG
• Latte	L
• Dark Blue	DB



30" Farmhouse Sink



30"x18"x10"

762x457x254 mm



89 lbs / 40.4 kg ( $\pm 2\%$ )



**Material: Fireclay**

### ■ Warranty

- Lifetime Limited Warranty



**NOTE:** Kindly be aware that a cutout template is not included with our fireclay sinks. Due to the manufacturing process of these sinks means that there can be slight variations in size ( $\pm 2\%$ ). To ensure a precise fit, we suggest using the sink itself to measure and trace any needed cutouts in your countertop or cabinetry. This method guarantees a perfect match for your specific fireclay sink.

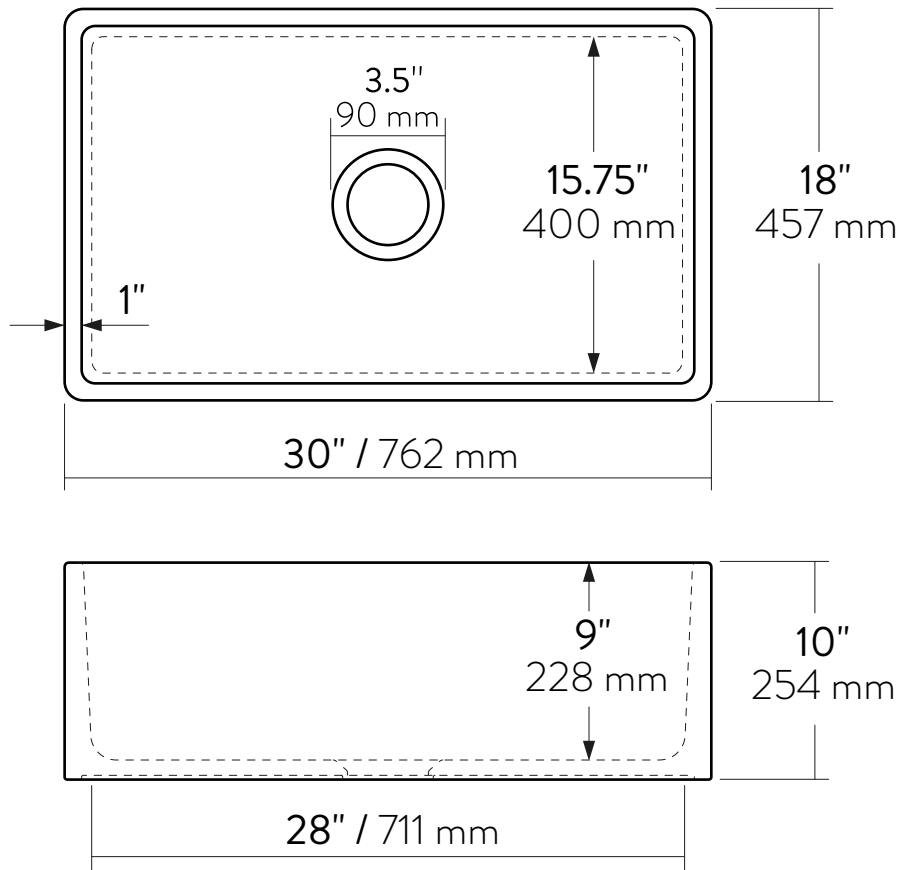

**■ Technical Measurements**

**INTERNAL DIMENSIONS**

- Length : 28" / 711 mm
- Width : 15.75" / 400 mm
- Bowl Depth: 9" / 228 mm

**EXTERNAL DIMENSIONS**

- Length : 30" / 762 mm
- Width : 18" / 457 mm
- Height : 10" / 254 mm

**NOTE:** Kindly be aware that there may be a slight variations in size, typically within the range of  $\pm 2\%$ , with our fireclay sinks. This is due to the manufacturing process of these sinks, which may result in slight size variation.

**IMPORTANT:** Velanso reserves the right to change the details of the documents. For the most recent documents visit [velanso.com](http://velanso.com).

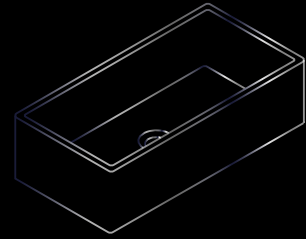
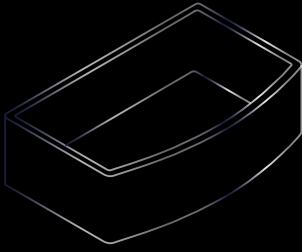

# VELANSO

## Fiche De Spécifications

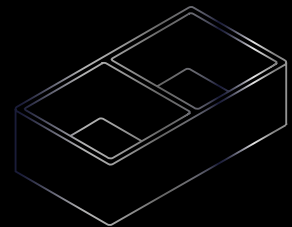
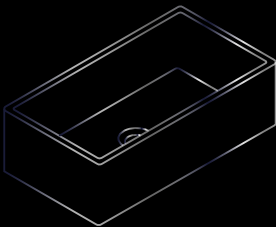

Modèle: F8030

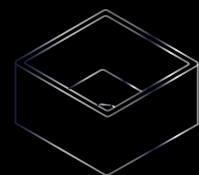
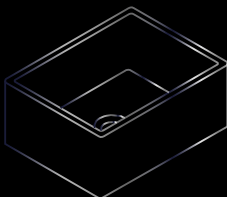
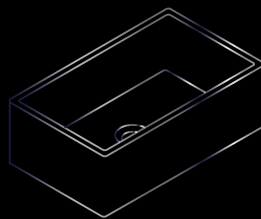

**Code Modèle:** F8030

## ■ Caractéristiques

- Bol Simple
- Ouverture De Vidange De 3.5"
- Pour meuble de base minimum de 33"
- Drain Central
- Matériau : Argile Réfractaire
- Installation À Fleur De Plan Ou Sous Plan



## ■ Couleurs Disponibles

NOM	CODE
• Blanc Brillant	BW
• Blanc Mat	MW
• Noir Brillant	BB
• Noir Mat	MB
• Anthracite	A
• Moutarde	M
• Gris Argenté	SG
• Latte	L
• Bleu Foncé	DB



Évier De Ferme De 30"



30"x18"x10"

762x457x254 mm



89 lbs / 40.4 kg (±2%)



Matériau : Argile Réfractaire

## ■ Garantie

- Garantie Limitée À Vie



**NOTE:** Veuillez noter qu'un gabarit de découpe n'est pas inclus avec nos éviers en argile réfractaire. En raison du processus de fabrication de ces éviers, il peut y avoir de légères variations de taille (±2%). Pour garantir un ajustement précis, nous vous suggérons d'utiliser l'évier lui-même pour mesurer et tracer les découpes nécessaires sur votre plan de travail ou vos armoires. Cette méthode garantit un ajustement parfait pour votre évier en argile réfractaire spécifique.

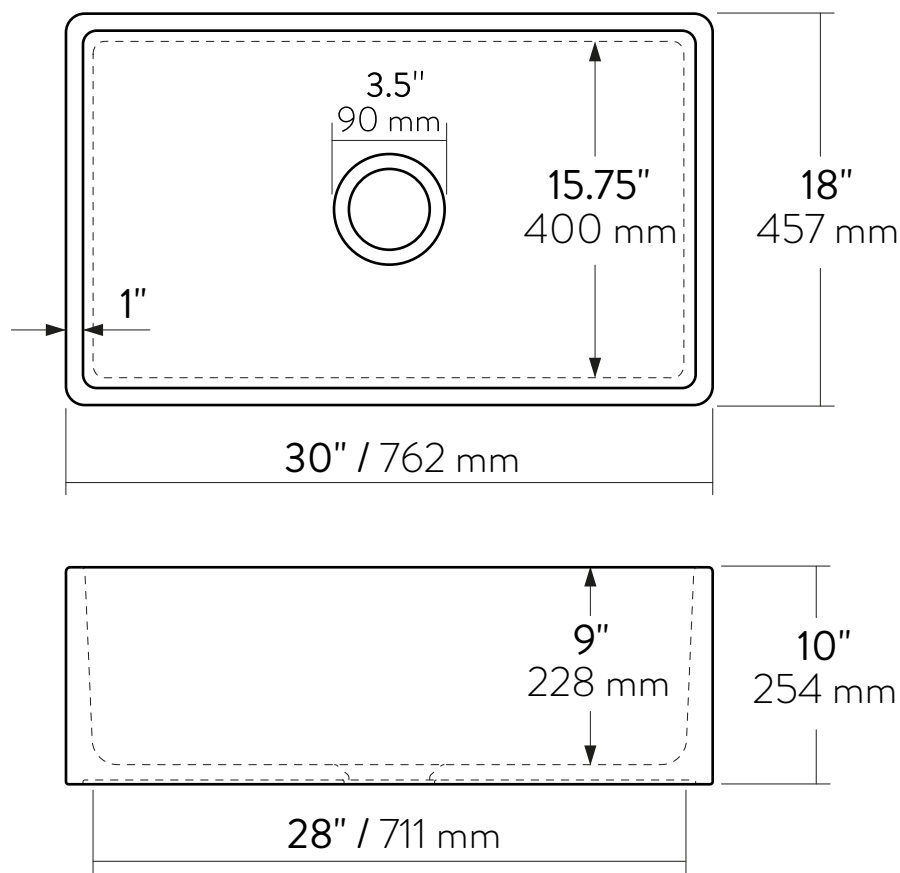

## ■ Mesures Techniques

### DIMENSIONS INTERNES

- Longueur : 28" / 711 mm
- Largeur : 15.75" / 400 mm
- Profondeur du Bol : 9" / 228 mm

### DIMENSIONS EXTERNES

- Longueur : 30" / 762 mm
- Largeur : 18" / 457 mm
- Hauteur : 10" / 254 mm

**NOTE:** Veuillez noter qu'il peut y avoir de légères variations de taille, généralement dans la plage de  $\pm 2\%$ , avec nos éviers en argile réfractaire. Ceci est dû au processus de fabrication de ces éviers, ce qui peut entraîner une légère variation de taille.

**IMPORTANT:** Velanso se réserve le droit de modifier les détails des documents. Pour les documents les plus récents, visitez [velanso.com](http://velanso.com).