

VELANSO

Specification Sheet

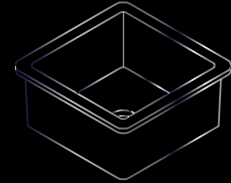

Model: U9031

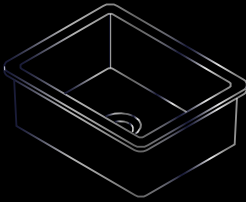
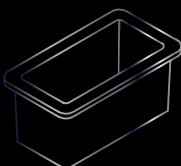
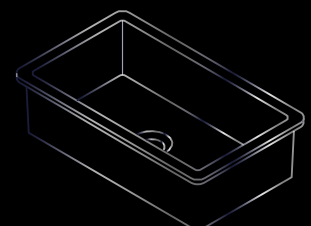
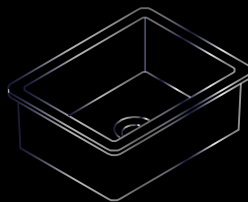

www.velanso.com

Model Code: U9031

■ Features

- Single Bowl
- 3.5" Drain Opening
- Fit Minimum 34" Base Cabinet
- Center Drain
- Material: Fireclay
- Undermount installation

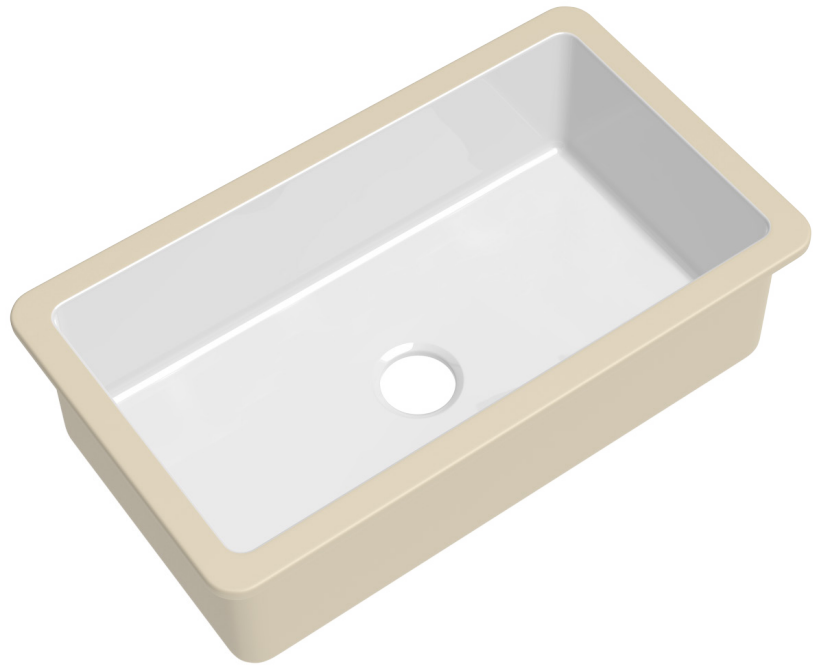

■ Available Colors

NAME	CODE
• Bright White	BW
• Matte White	MW
• Bright Black	BB
• Matte Black	MB
• Anthracite	A
• Mustard	M
• Silver Gray	SG
• Latte	L
• Dark Blue	DB

■ Warranty

- Lifetime Limited Warranty



31.25" Undermount Sink



31.25"x18"x8.5"

793x457x216 mm



52 lbs / 23.6 kg ($\pm 2\%$)



Material: Fireclay

NOTE: Kindly be aware that a cutout template is not included with our fireclay sinks. Due to the manufacturing process of these sinks means that there can be slight variations in size ($\pm 2\%$). To ensure a precise fit, we suggest using the sink itself to measure and trace any needed cutouts in your countertop or cabinetry. This method guarantees a perfect match for your specific fireclay sink.

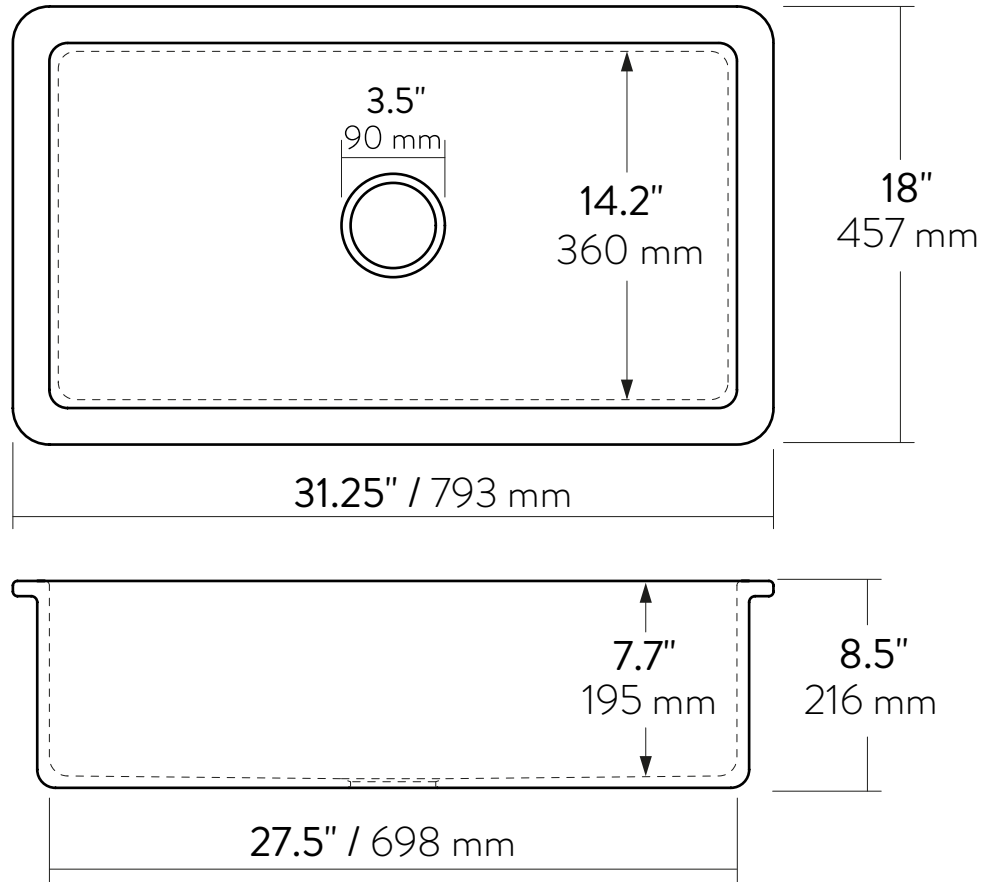

■ Technical Measurements

INTERNAL DIMENSIONS

- Length : 27.5" / 698 mm
- Width : 14.2" / 360 mm
- Bowl Depth: 7.7" / 195 mm

EXTERNAL DIMENSIONS

- Length : 31.25" / 793 mm
- Width : 18" / 457 mm
- Height : 8.5" / 216 mm

NOTE: Kindly be aware that there may be a slight variations in size, typically within the range of $\pm 2\%$, with our fireclay sinks. This is due to the manufacturing process of these sinks, which may result in slight size variation.

IMPORTANT: Velanso reserves the right to change the details of the documents. For the most recent documents visit velanso.com.

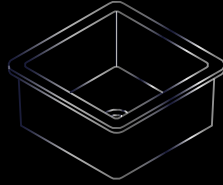
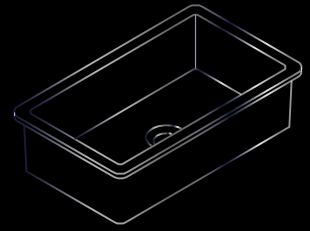
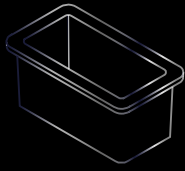

VELANSO

Fiche De Spécifications

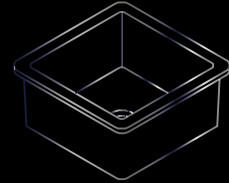
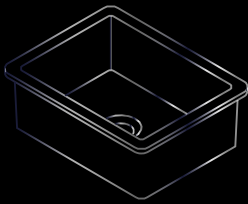

Modèle: U9031

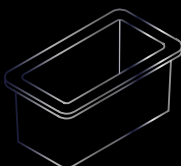
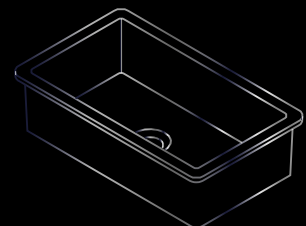
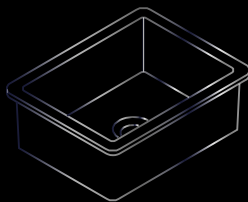

www.velanso.com

Code Du Modèle: U9031

■ Caractéristiques

- Bol Simple
- Ouverture De Vidange De 3.5"
- Pour Meuble De Base Minimum De 34"
- Drain Central
- Matériau : Argile Réfractaire
- Installation Sous Plan

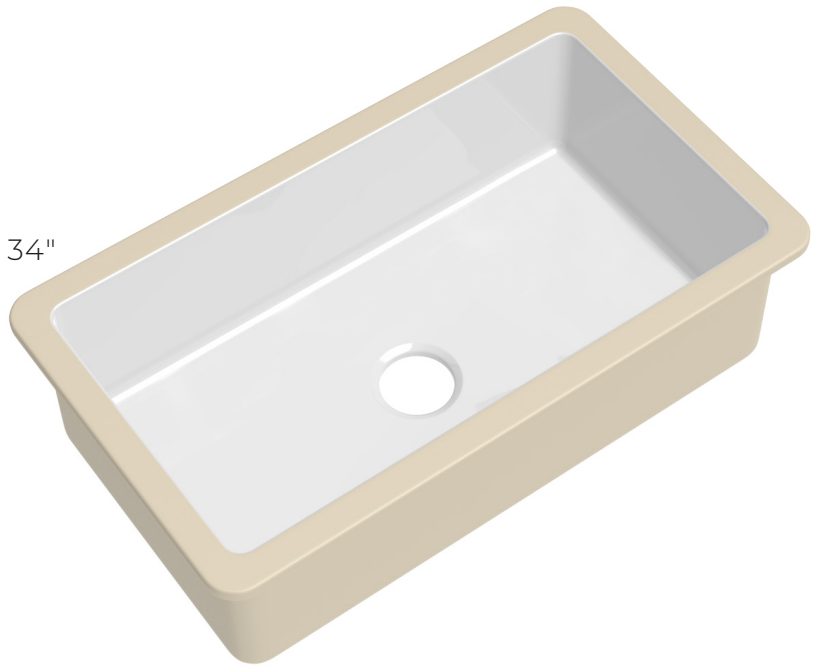

■ Couleurs Disponibles

NOM	CODE
• Blanc Brillant	BW
• Blanc Mat	MW
• Noir Brillant	BB
• Noir Mat	MB
• Anthracite	A
• Moutarde	M
• Gris Argenté	SG
• Latte	L
• Bleu Foncé	DB



Évier Sous Plan De 31,25"



31.25"x18"x8.5"

793x457x216 mm



52 lbs / 23.6 kg (±2%)



Matériau : Argile Réfractaire

■ Garantie

- Garantie limitée à vie



NOTE: Veuillez noter qu'un gabarit de découpe n'est pas inclus avec nos éviers en argile réfractaire. En raison du processus de fabrication de ces éviers, il peut y avoir de légères variations de taille (±2%). Pour garantir un ajustement précis, nous vous suggérons d'utiliser l'évier lui-même pour mesurer et tracer les coupes nécessaires sur votre plan de travail ou vos armoires. Cette méthode garantit un ajustement parfait pour votre évier en argile réfractaire spécifique.

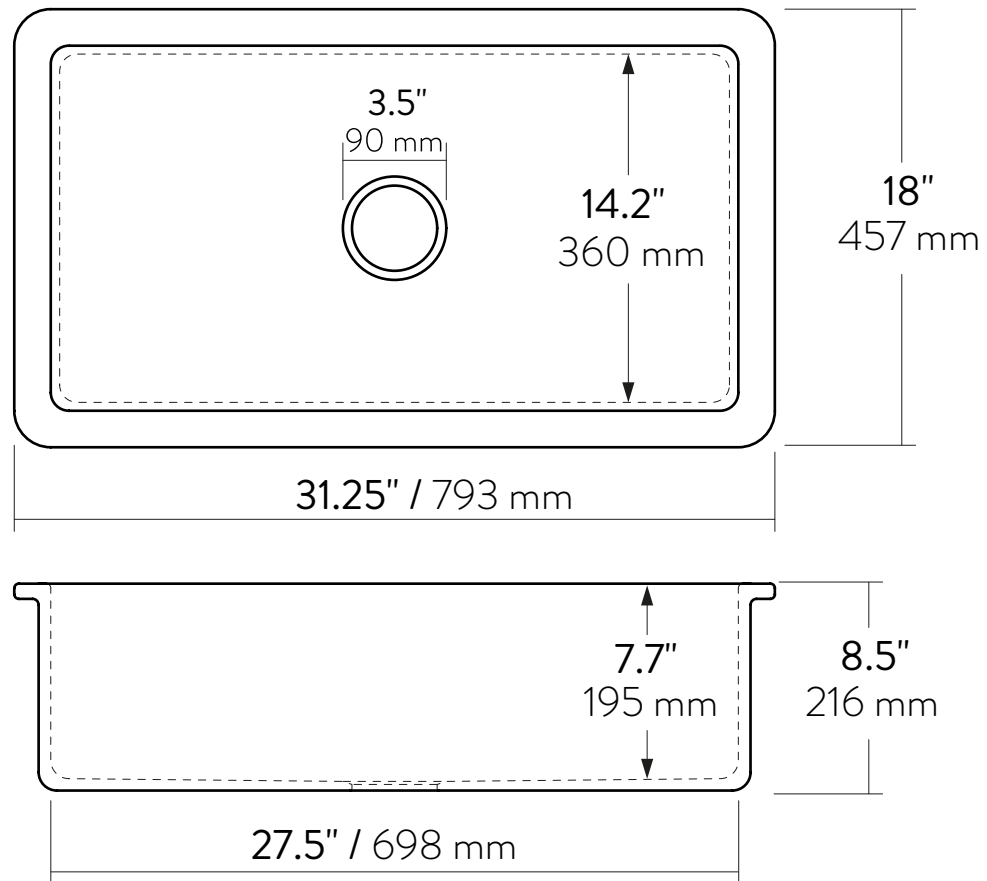

■ Mesures Techniques

DIMENSIONS INTERNES

- Longueur : 27.5" / 698 mm
- Largeur : 14.2" / 360 mm
- Profondeur du Bol : 7.7" / 195 mm

DIMENSIONS EXTERNES

- Longueur : 31.25" / 793 mm
- Largeur : 18" / 457 mm
- Hauteur : 8.5" / 216 mm

NOTE: Veuillez noter qu'il peut y avoir de légères variations de taille, généralement dans la plage de $\pm 2\%$, avec nos éviers en argile réfractaire. Ceci est dû au processus de fabrication de ces éviers, ce qui peut entraîner une légère variation de taille.

IMPORTANT: Velanso se réserve le droit de modifier les détails des documents. Pour les documents les plus récents, visitez velanso.com.